

# WizFi360 Datasheet

## (Version 1.01)



---

**Document Revision History**

<b>Date</b>	<b>Revision</b>	<b>Changes</b>
2019-07-26	V0.9	Temporary Release
2019-09-02	V1.0	Edited "5. Pin Definitions" Added "5.1 Initial Value of GPIO Pins" Added "Figure3. WizFi360 Pinout"
2019-09-19	V1.01	Edited "Figure3. WizFi360 Pinout" Edited "Table4. WizFi360 Pin Function" Added "7. Peripheral Circuit Reference Design" Added "8. Recommended PCB Land Pattern" Added "9. Reflow Condition"

## Table of Contents

1. Overview .....	4
2. Features .....	4
3. Parameters .....	5
4. Package Information .....	7
4.1. WizFi360-PA .....	7
4.2. WizFi360-CON .....	7
5. Pin Definitions .....	8
5.1. Initial Value of GPIO Pins .....	9
6. Physical Dimensions .....	10
6.1. WizFi360-PA Dimensions .....	10
6.2. WizFi360-CON Dimensions .....	11
7. Peripheral Circuit Reference Design .....	12
8. Recommended PCB Land Pattern .....	13
9. Reflow Profile .....	14
10. Important Notice .....	15

---

## 1. Overview

WizFi360 is a low cost and low-power consumption industrial-grade WiFi module. It is compatible with IEEE802.11 b/g/n standard and supports SoftAP, Station and SoftAP+Station modes. The serial port baud rate can be up to 2Mbps, which can meet the requirement of various applications.

## 2. Features

- WiFi 2.4G, 802.11 b/g/n
- Support Station / SoftAP / SoftAP+Station operation modes
- Support "Data pass-through" and "AT command data transfer" mode
- Support serial AT command configuration
- Support TCP Server / TCP Client / UDP operating mode
- Support configuration of operating channel 0 ~ 13
- Support auto 20MHz / 40MHz bandwidth
- Support WPA\_PSK / WPA2\_PSK encryption
- Serial port baud rate up from 600bps to 2Mbps with 16 common values
- Support up to 5 TCP / UDP links
- Obtaining IP address automatically from the DHCP server (Station mode)
- DHCP service for Wireless LAN clients (AP mode)
- Support DNS for communication with servers by domain name
- Support "Keep-Alive" to monitor TCP connection
- Support "Ping" for monitoring network status
- Built-in SNTP client for receiving the network time
- Support built-in unique MAC address and user configurable
- Support firmware upgrade by UART Download / OTA (via WLAN)
- Industrial grade (operating temperature range: -40 ° C ~ 85 ° C)
- CE, FCC, KC certification

### 3. Parameters

Categories	Items	Values
Wireless	Wireless Standard	802.11 b/g/n
	Frequency Range	2.4GHz-2.5GHz ( 2400MHz~2483.5MHz )
Hardware	Serial Data Interface	3.3V TTL×1 : TXD、RXD、CTS、RTS、GND
	Operating Voltage	3.0~3.6V ( Typical 3.3V )
	Operating Temperature	-40°C ~85°C
Software	WiFi Operation Modes	Station / SoftAP / SoftAP + Station
	Encryption Method	WPA_PSK/WPA2_PSK
	Operation Modes	TCP Server/TCP Client/UDP
	Configuration Mode	AT commend set
	Firmware Upgrade	UART Download / OTA (via WLAN) upgrade
Certification Report		CE, FCC, KC

**Table 1. Parameters**

Parameter	Typical value	Unit
Input Frequency	2400~2484	MHz
<b>Output Power</b>		
PA Output Power at 72.2Mbps	12	dBm
PA Output Power in 802.11b	19	dBm
<b>Sensitivity</b>		
DSSS,1 Mbps	-95	dBm
CCK,11 Mbps	-86	dBm
OFDM,6 Mbps	-89	dBm
OFDM,54 Mbps	-73	dBm
HT20, MCS0	-89	dBm
HT20, MCS7	-71	dBm
<b>Adjacent-channel interference (ACI)</b>		
OFDM,6 Mbps	32	dB
OFDM,54 Mbps	15	dB
HT20, MCS0	29	dB
HT20, MCS7	10	dB

**Table 2. Receiver Sensitivity**

Mode	Typical	Unit
Send IEEE802.11b, CCK 11Mbps, POUT = +19 dBm	230	mA
Send IEEE802.11g, OFDM 54Mbps, POUT = +13.5 dBm	210	mA
Send IEEE802.11n, OFDM MCS7, POUT = +12dBm	210	mA
Receive IEEE802.11 b/g/n	100-110	mA
Standby Mode	135	uA
Modem Sleep Mode	15	mA
Light Sleep Mode	13	mA

**Table 3. Description on Power Consumption**

- Standby mode
  - MCU will shut down all the peripherals and CPU will be powered down too. CPU can be wake up by external WP(WAKEUP) PIN or internal Timer.
- Modem Sleep mode
  - All peripherals of the MCU will operate.
- Light Sleep mode
  - Shutdown peripheral except for UART, TIMER, RFCFG GPSED

## 4. Package Information

### 4.1. WizFi360-PA

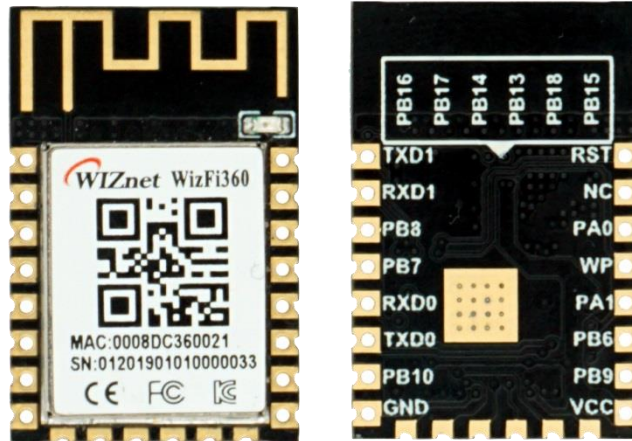

Figure 1. WizFi360-PA

- Onboard PCB antenna
- Onboard LED light, TX/RX LED
- Dimension: 24×16×3.2 (mm)

### 4.2. WizFi360-CON

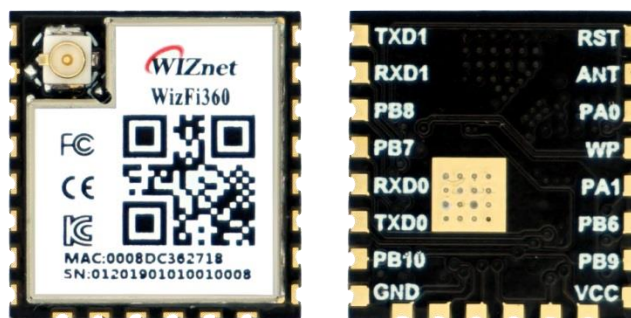

Figure 2. WizFi360-CON

- Onboard IPEX connector for connecting antenna
- ANT pin for external antenna
- Dimension: 17 × 16 × 3.2 (mm)

## 5. Pin Definitions

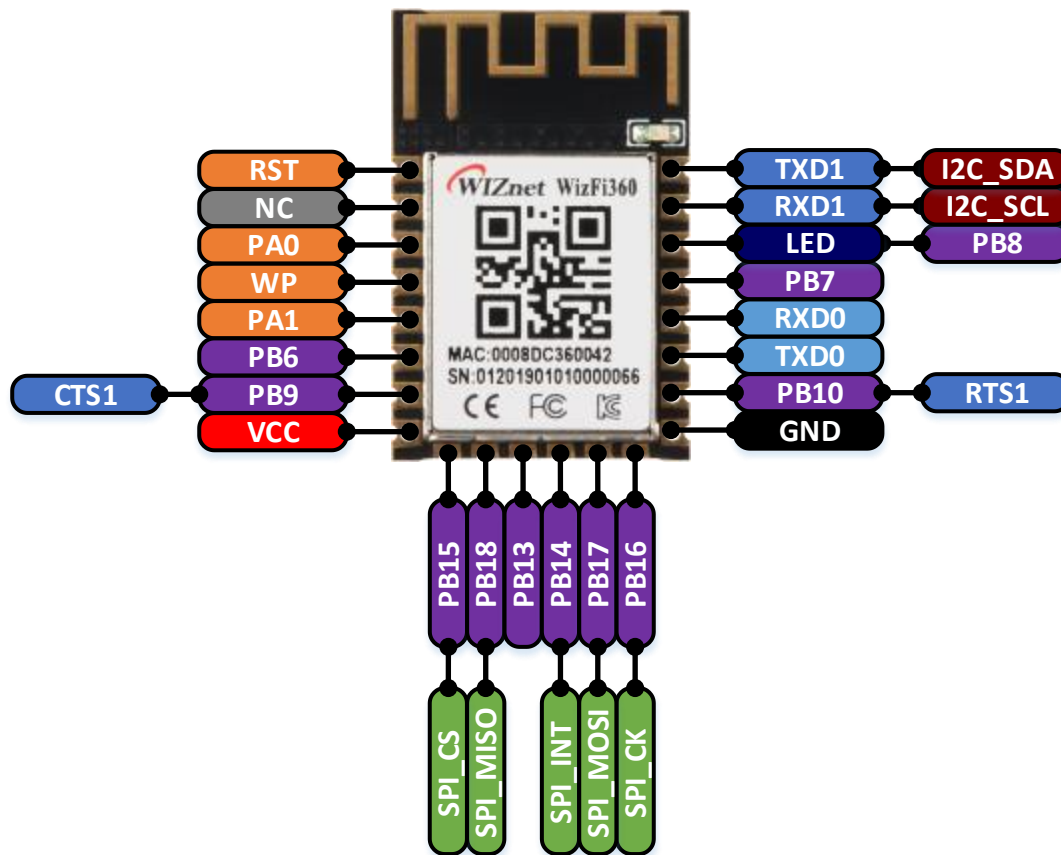

Figure 3. WizFi360 Pinout

No	Pin Name	Type	Pin Function	
1	RST	I	Module Reset Pin (Active Low)	
2	NC	-	WizFi360-PA	Reserved
	ANT	O	WizFi360-CON	ANT pin for external antenna
3	PA0	I/O	BOOT Pin (Active low) <b>When power on or reset is low, it operates in Boot mode.</b> In the normal operating mode, this pin can be controlled by AT command.	
4	WP	I	WAKE-UP Pin (Active High) If the wake-up pin is high in Standby mode, the WizFi360 is reset to the normal operating mode.	
5	PA1	I	Pull down over 3s for taking effect. <b>UART1's current parameter changes to default value (please refer to the AT+UART_CUR command in WizFi360 AT command manual).</b>	
6	PB6	I/O	This pin can be controlled by AT command.	
7	PB9	I	CTS Pin of UART1 If you don't use the CTS function, this pin can be controlled by AT	



			command.
<b>8</b>	VCC	P	Power Pin (Typical Value 3.3V)
<b>9</b>	PB15	I/O	This pin can be controlled by AT command.
<b>10</b>	PB18	I/O	This pin can be controlled by AT command.
<b>11</b>	PB13	I/O	This pin can be controlled by AT command.
<b>12</b>	PB14	I/O	This pin can be controlled by AT command.
<b>13</b>	PB17	I/O	This pin can be controlled by AT command.
<b>14</b>	PB16	I/O	This pin can be controlled by AT command.
<b>15</b>	GND	I/O	Ground Pin
<b>16</b>	PB10	O	RTS Pin of UART1 If you don't use the RTS function, this pin can be controlled by AT command.
<b>17</b>	TXD0	O	TXD Pin of UART0
<b>18</b>	RXD0	I	RXD Pin of UART0
<b>19</b>	PB7	O	LED Light output (Active low). Go to Low while each TX/RX packet and then back to high. Note: It has been connected to onboard LED for WizFi360-PA
<b>20</b>	PB8	I/O	This pin can be controlled by AT command.
<b>21</b>	<b>RXD1</b>	<b>I</b>	<b>RXD Pin of UART1</b>
<b>22</b>	<b>TXD1</b>	<b>O</b>	<b>TXD Pin of UART1</b>

**Table 4. WizFi360 Pin Function**

**\*Note: UART1 is used for AT command and data communication. UART0 is used for debugging and firmware upgrade.**

## 5.1. Initial Value of GPIO Pins

This is the initial value of GPIO when using AT command to use GPIO on the WizFi360.

Pin Name	Type	Value	Pull up / Pull down
PA0	I/O	High	Pull up
PB6	I/O	Low	Pull down
PB9	I/O	Low	Pull down
PB15	I/O	High	Pull down
PB18	I/O	High	Pull down
PB13	I/O	High	Pull down
PB14	I/O	High	Pull down

PB17	I/O	High	Pull down
PB16	I/O	High	Pull down
PB10	I/O	Low	Pull down
PB07	I/O	High	Pull down
PB08	I/O	High	Pull down

**Table 5. Initial Value of GPIO Pins**

## 6. Physical Dimensions

### 6.1. WizFi360-PA Dimensions

24(L) x 16(W) x 3.2(H) ( $\pm 0.1$ ), (unit: mm)

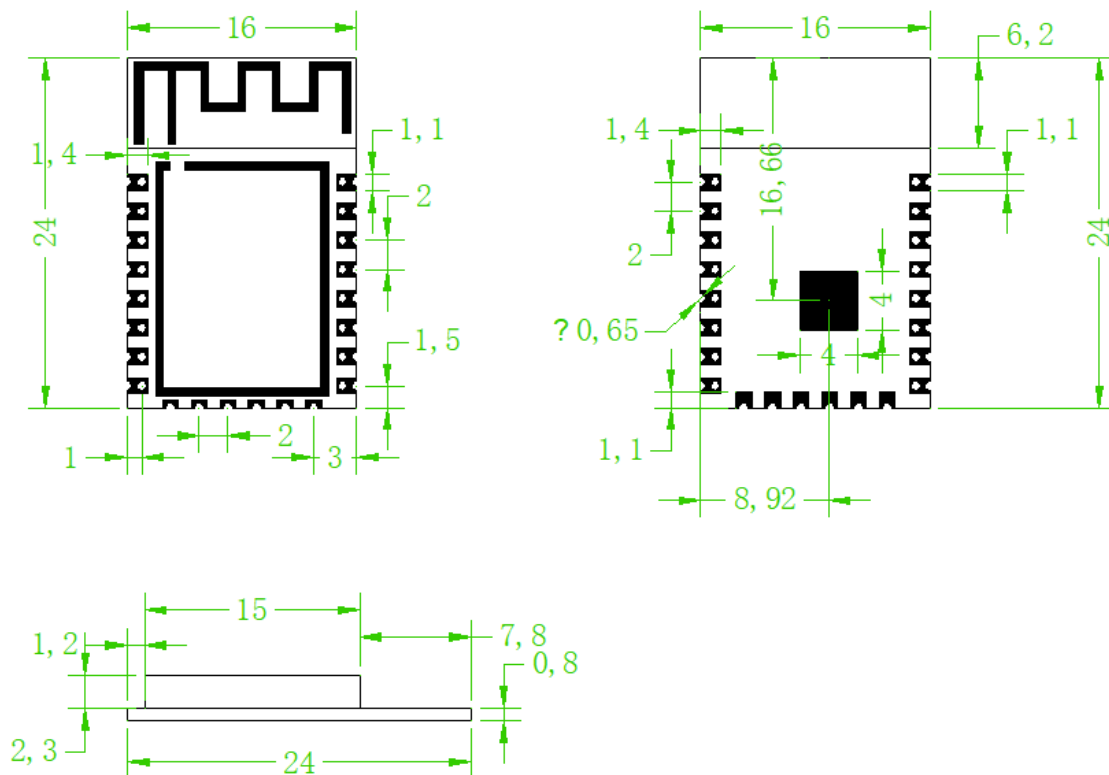

**Figure 4. WizFi360-PA Physical Dimensions**

## 6.2. WizFi360-CON Dimensions

17(L) x 16(W) x 3.2(H) ( $\pm 0.1$ ), (unit: mm)

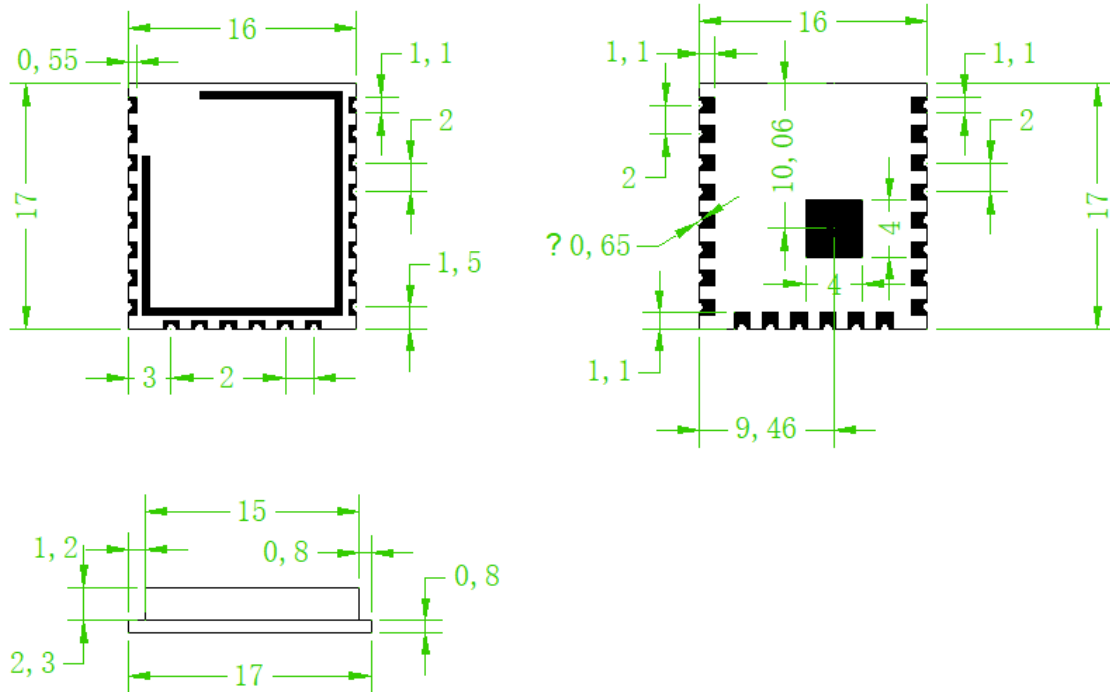

Figure 5. WizFi360-CON Physical Dimensions

## 7. Peripheral Circuit Reference Design

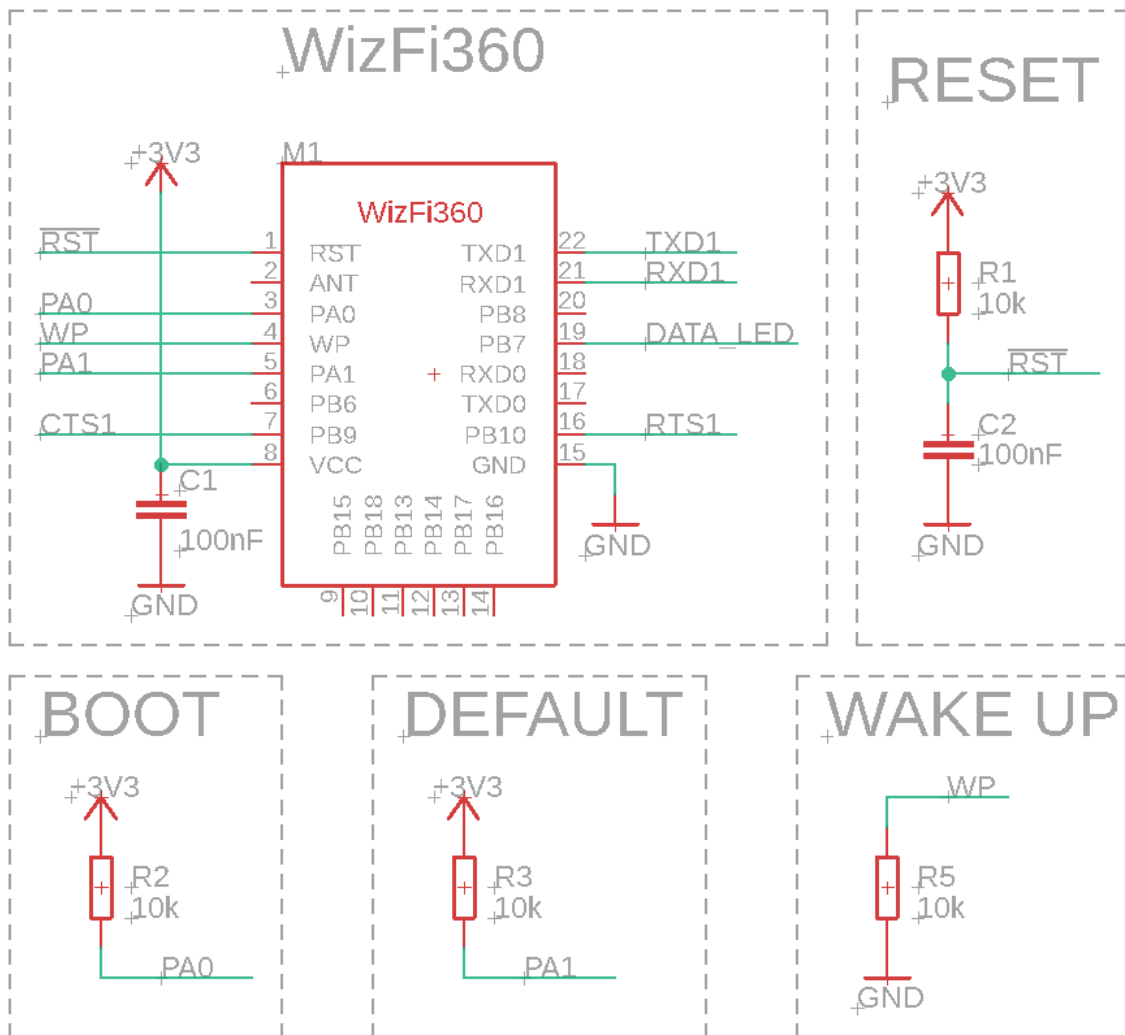

Figure 6. WizFi360 Circuit Reference Design

## 8. Recommended PCB Land Pattern

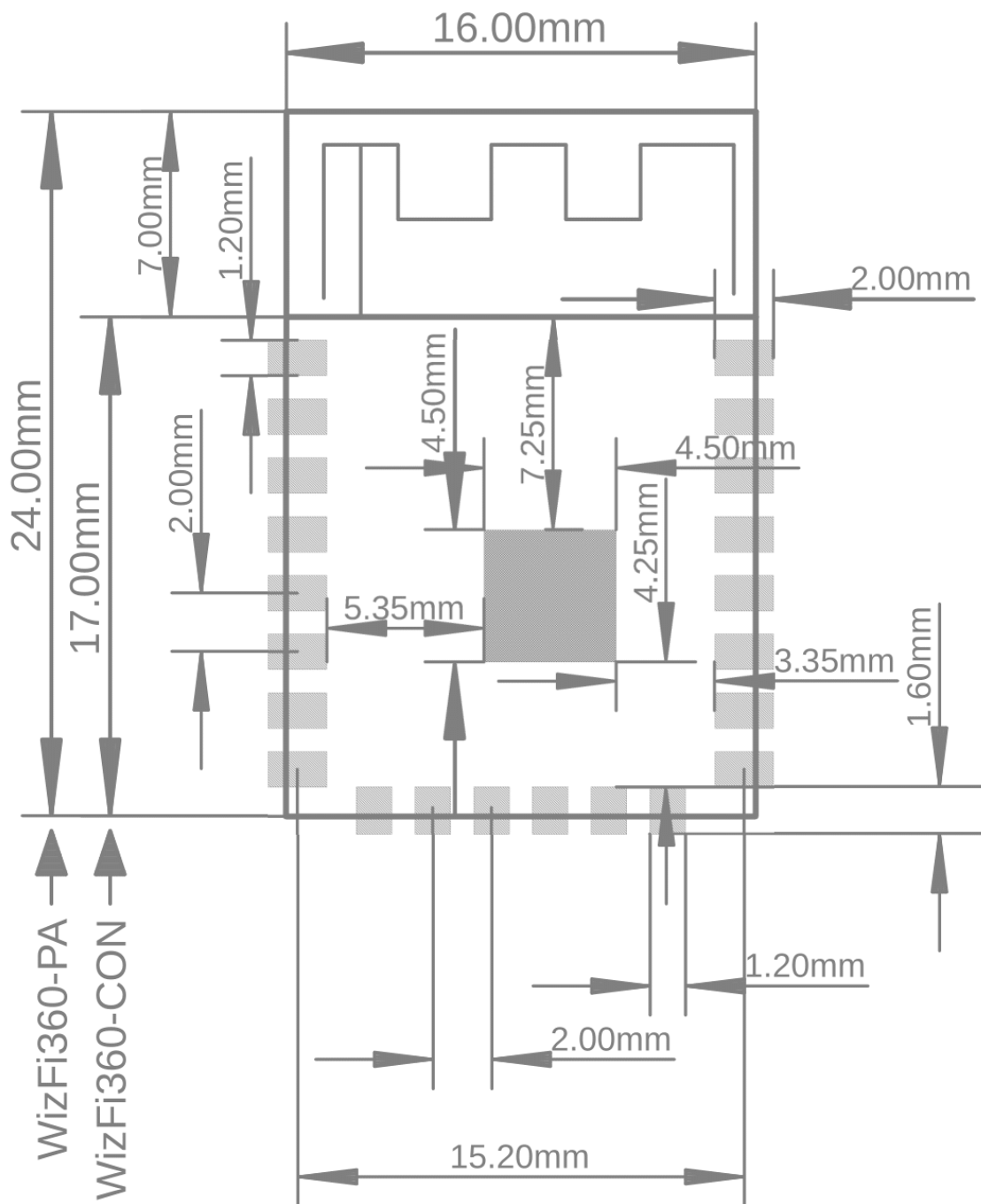

Figure 7. Recommended PCB Land Pattern of WizFi360

## 9. Reflow Condition

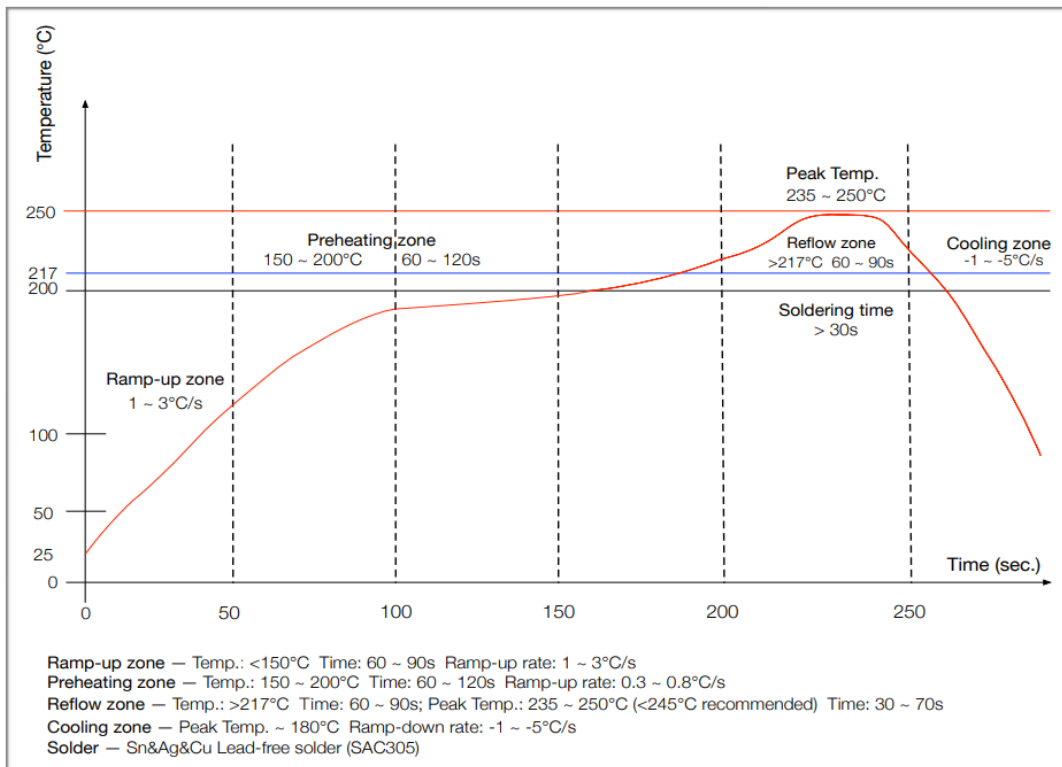

Figure 8. Reflow Condition

## 10. Important Notice

WIZnet reserves the right to make corrections, modifications, enhancements, improvements and other changes to its products and services at any time, and to discontinue any product or service without notice. Customers should obtain the latest relevant information before placing orders, and should verify that such information is current and complete. All products are sold subject to WIZnet's terms and conditions of sale, supplied at the time of order acknowledgment. Information relating to device applications, and the like, is intended as suggestion only and may be superseded by updates. It is the customer's responsibility to ensure that their application meets their own specifications. WIZnet makes no representation and gives no warranty relating to advice, support or customer product design.

WIZnet assumes no responsibilities or liabilities for the use of any of its products, conveys no license or title under any patent, copyright or mask work rights to these products, and makes no representations or warranties that these products are free from patent, copyright or mask work infringement, unless otherwise specified.

WIZnet products are not intended for use in life support systems/appliances or any systems where product malfunction can reasonably be expected to result in personal injury, death, severe property damage or environmental damage. WIZnet customers using or selling WIZnet products for use in such applications do so at their own risk and agree to fully indemnify WIZnet for any damages resulting from such use.

All trademarks are the property of their respective owners.

## Copyright Notice

Copyright 2019 WIZnet Co., Ltd. All Rights Reserved.

Technical Support: <https://forum.wiznet.io/>

Sales & Distribution: [sales@wiznet.io](mailto:sales@wiznet.io)

For more information, visit our website at <http://www.wiznet.io/>